

Slim 50 3 3x12W

EM236
empotrado recessed

3x1080Lm~3x1318Lm / 2700K~4000K

IP20 IP40 / CRI ≥ 90 / 25° 43° 60°

HER

Light Lovers.



GENERAL

negro black blanco white
customizable custom

empotrado recessed

IP20 IP40 (acces. FL055/FL060)

ángulo de inclinación +30° -30°

tilting angle: +30° -30°

IK07

APARATO DE ILUMINACIÓN LIGHTING FIXTURE

25° 43° 60°

IRC ≥ 90 CRI ≥ 90

IP20 IP40 (acces. FL055/FL060)

MacAdam ≤ 3

UGR N/A

difusor transparente

clear diffuser

valores de potencia del sistema (LED + driver): 3x13,2W

power values of the system (LED + driver): 3x13,2W

ACCESORIOS ACCESSORIES

FL040 Panel de abeja

FL040 honeycomb diffuser

FL055 Cristal transparente

FL055 transparent glass

FL060 Cristal glaseado

FL060 frosted glass

ELÉCTRICA ELECTRICAL

3x12W

220-240VAC 50/60Hz

equipo incluido

gear included

MEDIDAS MEASURES

244mm x 84mm

altura: 95mm

height: 95mm

REGULACIÓN DIMMING

on / off

corte de fase IGBT/TRIAC

phase-cut dimming IGBT/TRIAC

1-10V

pulsador

push

DALI

RECORTE CUTOUT

235 x 75mm

mín. espesor del techo: 13mm

min. ceiling thickness: 13mm

máx. espesor del techo: 25mm

max. ceiling thickness: 25mm

profundidad empotrada: 100mm

recessed depth: 100mm

DESCRIPCIÓN DESCRIPTION

Versión de triple proyección de la gama SLIM 50.

Triple lamp version of the SLIM 50 range.

REFERENCIAS REFERENCES

EM236/27	2700K	3x1080Lm	270Lm/W
EM236/30	3000K	3x1217Lm	304,3Lm/W
EM236/40	4000K	3x1318Lm	329,5Lm/W

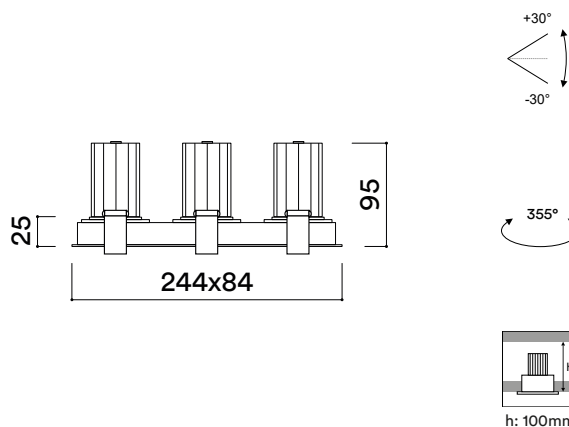

H(m)	D(cm)	Lux
1	45	12112
2	68	3028
3	135	1346

3000K 25°

H(m)	D(cm)	Lux
1	69	8906
2	138	2227
3	207	990

3000K 43°

H(m)	D(cm)	Lux
1	97	6270
2	193	1568
3	290	697

3000K 60°



cambio sin previo aviso change without notice

Slim 50 3 3x9W

EM233
empotrado recessed

3x683Lm~3x870Lm / 2700K~4000K

IP20 IP40 / CRI ≥ 90 / 20° 40° 60°

HER

Light Lovers.



GENERAL

negro black blanco white
customizable custom

empotrado recessed

IP20 IP40 (acces. FL055/FL060)

ángulo de inclinación +30° -30°

tilting angle: +30° -30°

IK07

APARATO DE ILUMINACIÓN LIGHTING FIXTURE

20° 40° 60°

IRC ≥ 90 CRI ≥ 90

IP20 IP40 (acces. FL055/FL060)

MacAdam ≤ 3

UGR N/A

difusor transparente

clear diffuser

valores de potencia del sistema (LED + driver): 3x9,9W

power values of the system (LED + driver): 3x9,9W

ACCESORIOS ACCESSORIES

FL040 Panel de abeja

FL040 honeycomb diffuser

FL055 Cristal transparente

FL055 transparent glass

FL060 Cristal glaseado

FL060 frosted glass

ELÉCTRICA ELECTRICAL

3x9W

220-240VAC 50/60Hz

equipo incluido

gear included

MEDIDAS MEASURES

244mm x 84mm

altura: 85mm

height: 85mm

REGULACIÓN DIMMING

on / off

corte de fase IGBT/TRIAC

phase-cut dimming IGBT/TRIAC

1-10V

pulsador

push

DALI

RECORTE CUTOUT

235 x 75mm

mín. espesor del techo: 13mm

min. ceiling thickness: 13mm

máx. espesor del techo: 25mm

max. ceiling thickness: 25mm

profundidad empotrada: 90mm

recessed depth: 90mm

DESCRIPCIÓN DESCRIPTION

Versión de triple proyección de la gama SLIM 50.

Triple lamp version of the SLIM 50 range.

REFERENCIAS REFERENCES

EM233/27	2700K	3x683Lm	227,7Lm/W
EM233/30	3000K	3x779Lm	259,7Lm/W
EM233/40	4000K	3x870Lm	290Lm/W

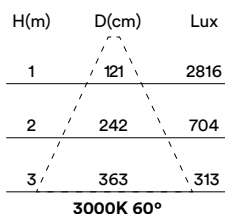
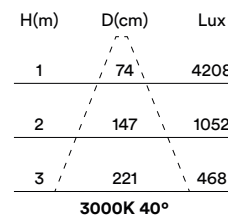
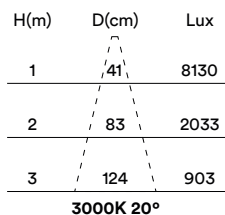
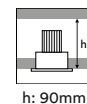
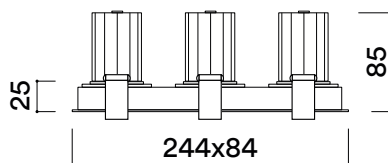
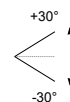

cambio sin previo aviso change without notice

Slim 50 3 3x8,3W

EM239
empotrado recessed

3x550Lm / 3000K
IP20 / CRI ≥ 90 / 36°

HER
Light Lovers.



GENERAL

negro black blanco white
customizable custom

empotrado recessed

IP20

ángulo de inclinación +30° -30°

tilting angle: +30° -30°

IK02

APARATO DE ILUMINACIÓN LIGHTING FIXTURE

36°

IRC ≥ 90 CRI ≥ 90

IP20

MacAdam ≤ 3

UGR N/A

difusor transparente

clear diffuser

valores de potencia del sistema (LED
+ driver): 3x9,1W

power values of the system (LED +
driver): 3x9,1W

ACCESORIOS ACCESSORIES

no disponible

not available

ELÉCTRICA ELECTRICAL

3x8,3W

220-240VAC 50/60Hz

equipo incluido

gear included

MEDIDAS MEASURES

244mm x 84mm

REGULACIÓN DIMMING

on / off

corte de fase IGBT/TRIAC

phase-cut dimming IGBT/TRIAC

RECORTE CUTOUT

235 x 75mm

min. espesor del techo: 13mm

min. ceiling thickness: 13mm

máx. espesor del techo: 25mm

max. ceiling thickness: 25mm

profundidad empotrada: 90mm

recessed depth: 90mm

DESCRIPCIÓN DESCRIPTION

Versión de triple proyección de la gama SLIM 50.

Triple lamp version of the SLIM 50 range.

REFERENCIAS REFERENCES

EM239	3000K	3x550Lm	198,8Lm/W
-------	-------	---------	-----------

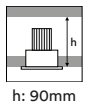

cambio sin previo aviso change without notice